

ASSEMBLY INSTRUCTIONS

ITEM NO:T4717-3PK



Thank you for purchasing this quality product .Be sure to check all packing material carefully for small parts that may have come loose inside the carton during shipment.

Step 1:Please follow chart to assembly table leg B and table top A,But don't tighten the long blot.

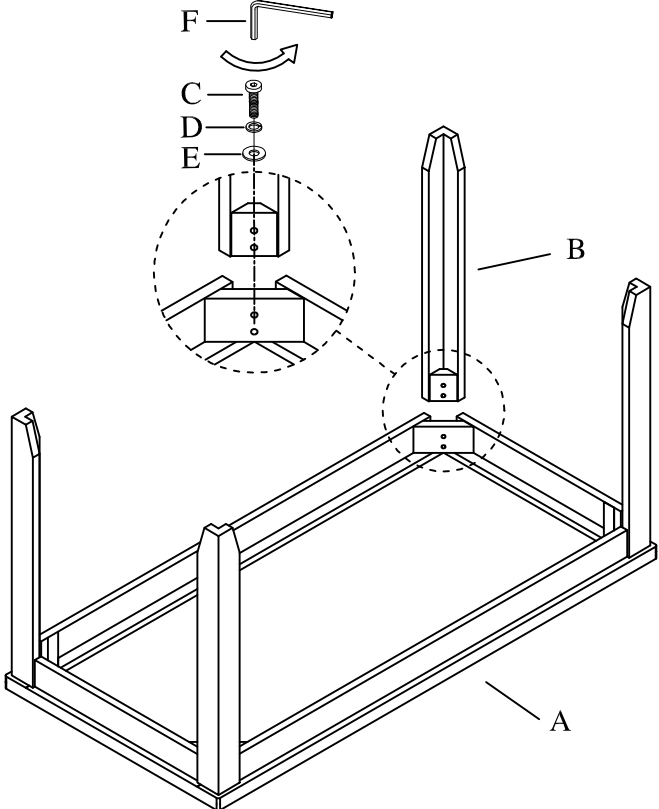

TOOLS REQUIRED(NOT PROVIDED):
PHILLIPS SCREWDRIVER 







PARTS LIST:

NO.	Description	Sketch	Quantity
A	Top		1PC
B	Leg		4PCS

PARTS LIST:

NO.	Description	Sketch	Quantity
A	Top		2PCS
B	Leg		8PCS

HARDWARE LIST:

NO.	Description	Sketch	Size	Quantity
C	Long Blot		φ1/4"*2-1/2"L	24 PCS
D	Lock Washer		φ1/4"	24 PCS
E	Spring Washer		φ1/4"	24 PCS
F	Allen Key		4mm	1PC

NOTE: Straight Allen Key(k)is for use with a power drill.

